

MARY ZHANG

INDUSTRIAL DESIGN 2023 PORTFOLIO

Hello!

I'm YOUHUA ZHANG

PERSONAL EXPERIENCE

Participated in the public service program "Wetland Bird Conservation".

Participated in painting training for 3 years

Participated in the "Caring for Autistic Children" public service program.

EDUCATION

2021
-
2024 Responsible for Industrial design

LANGUAGES

English
Chinese

SKILLSET



Sketching



Indesign



Illustration



Photoshop



3d Software



Keyshot



1

ComboDesk

Classroom desk and chair set



2

Kao Soap

Bath Soap



3

SOLOIST

Saxophone microphone



4

Personal Projects

Sketching and CAD skills

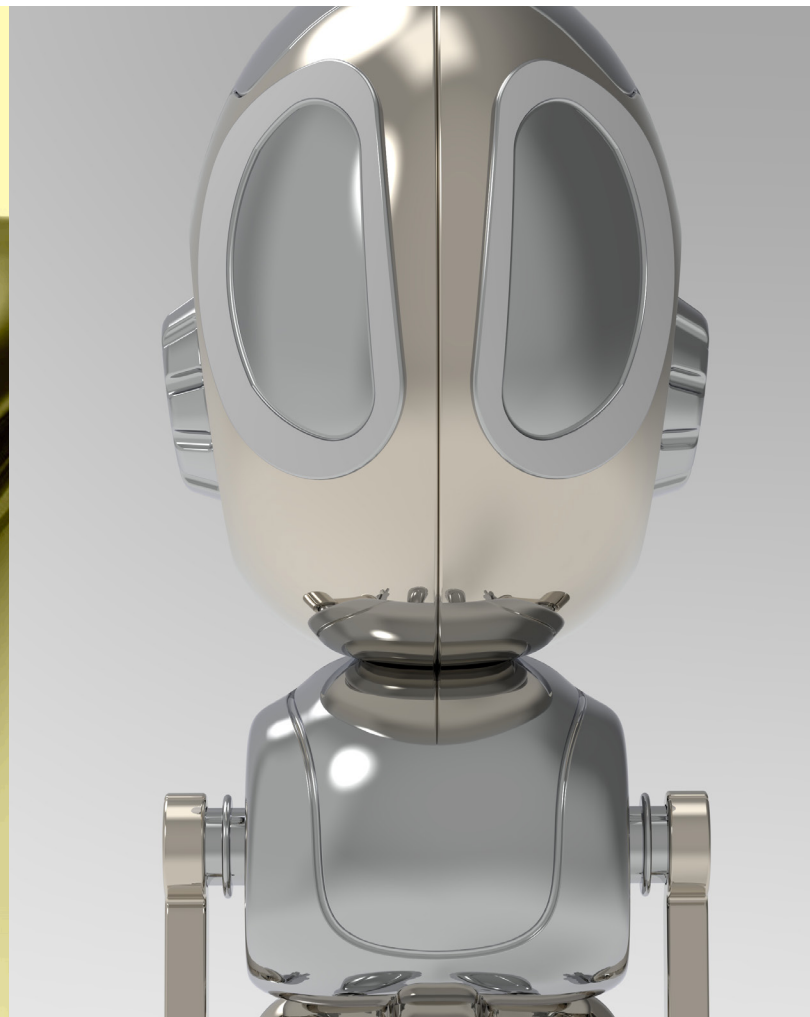

COMBO DESK

A classroom desk and chair set that combines desks and chairs into a single unit



CURRENT PROBLEMS

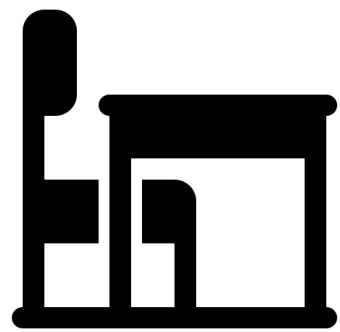

Space-saving



Lack of storage space



Sharp corner

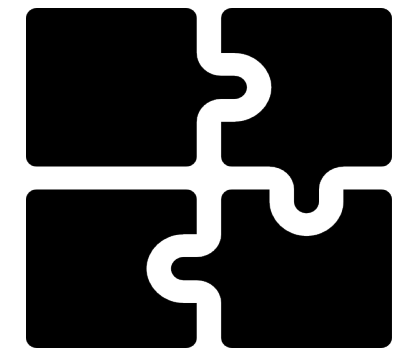

Easy to assemble

SKETCHS AND INSPIRATIONS



Stepped shapes
One Unit

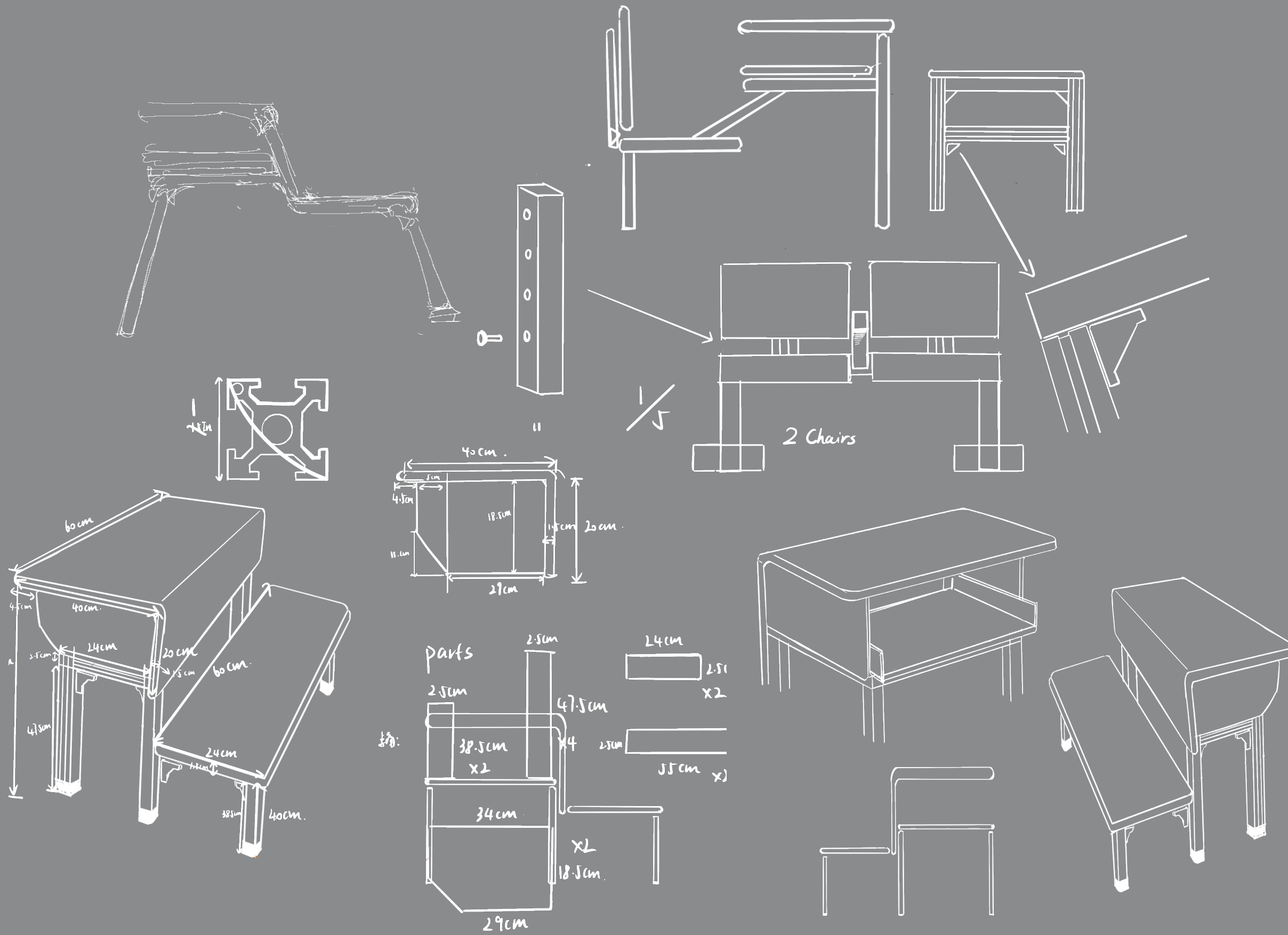

MODEL
MAKING



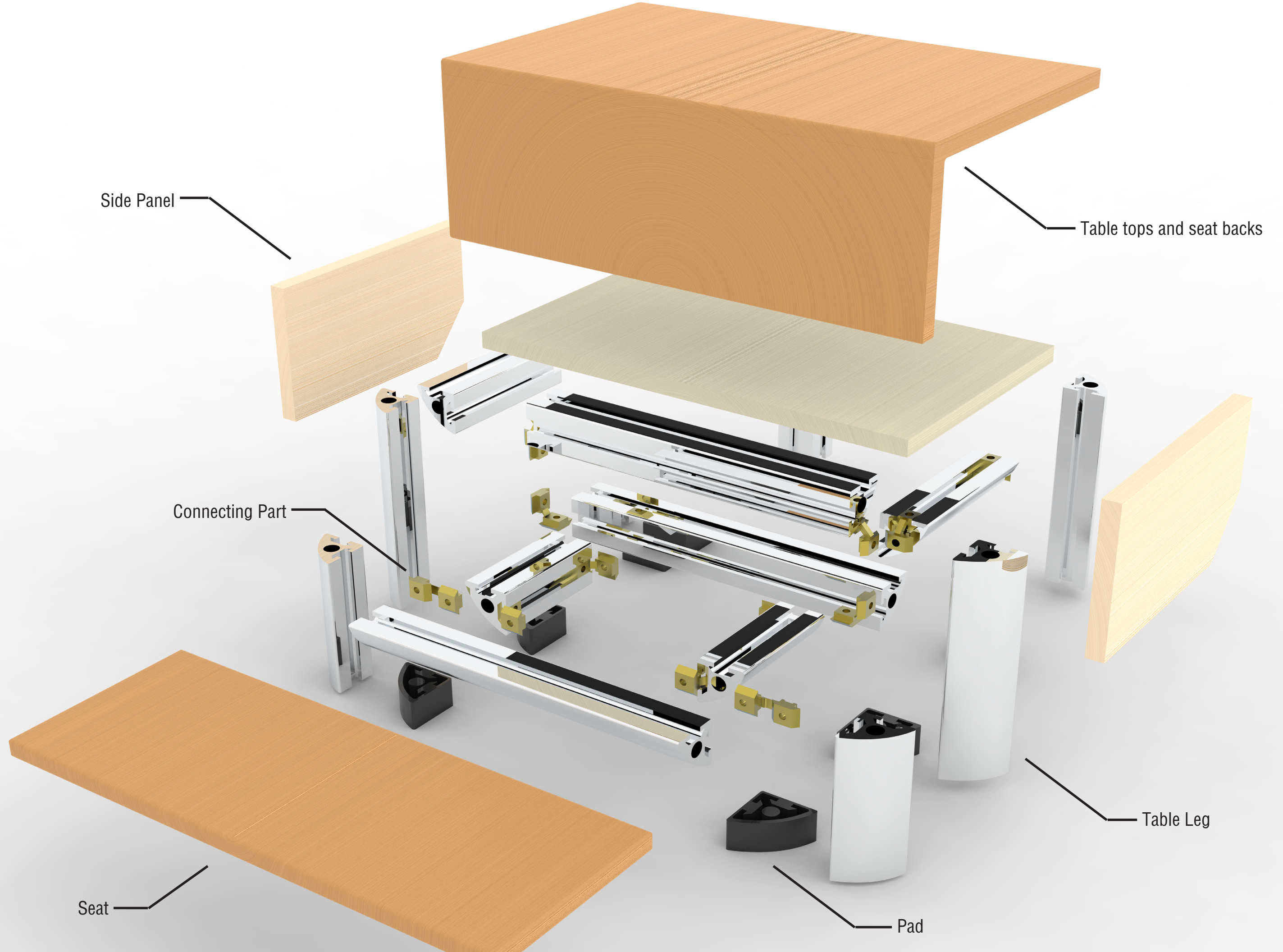

Side Panel

Table tops and seat backs

Connecting Part

Seat

Pad

Table Leg

DETAIL PARTS

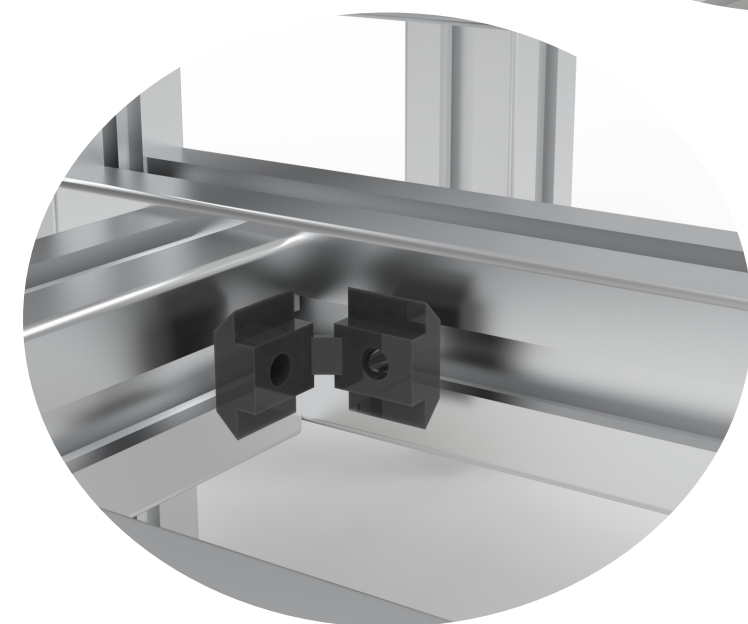

FINAL
RENDERING





Kao Soap

Shower soap for the Kao brand

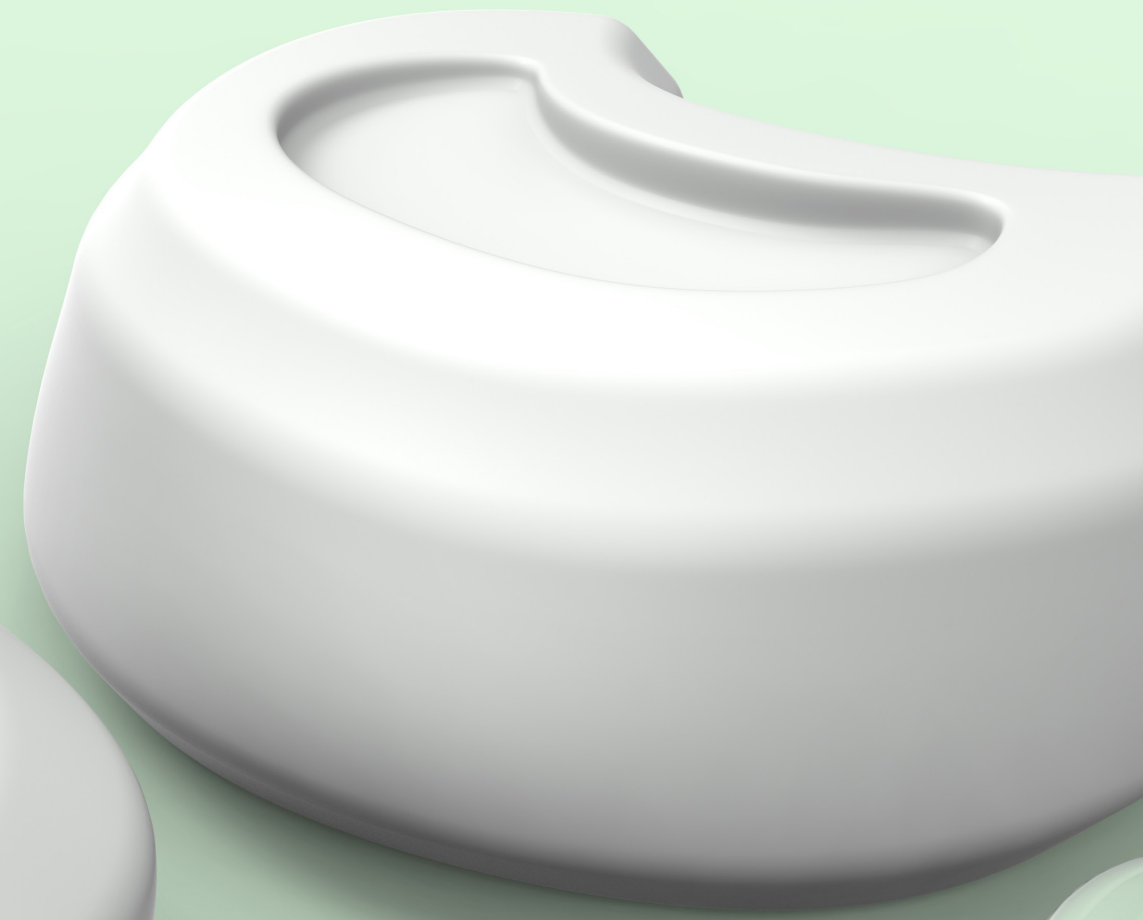

打开自然
融化你的忙碌

森林香型
全新上市

めぐりズム
花王 美舒律
蒸汽眼罩
働き続けた目にじんわり
約40℃
蒸気浴
約20分
新 轻柔感眼罩体験
伊藤野道 船之尾幸

地肌まで
すっきり!

めぐりズム
Shampoo
メリット

地肌まで
すっきり!

Shampoo
メリット

洗うで選ぼう。

素肌を
やさしく
柔らかく
に
こだわりました。

ふわ
ふわ

わ
わ
ハミング
素肌おもい

New

ハミング
実顔がみ
ハミング
実顔がみ
ハミング
実顔がみ
無香料

うすづきで
ムダなし!

うすづき
ムダなし!

※CM用に色を強めています。使用環境によって異なります。

Brand: Kao

Gentle, affordable, fresh

SKETCHES

INSPIRATION:



MODEL
PROCESS

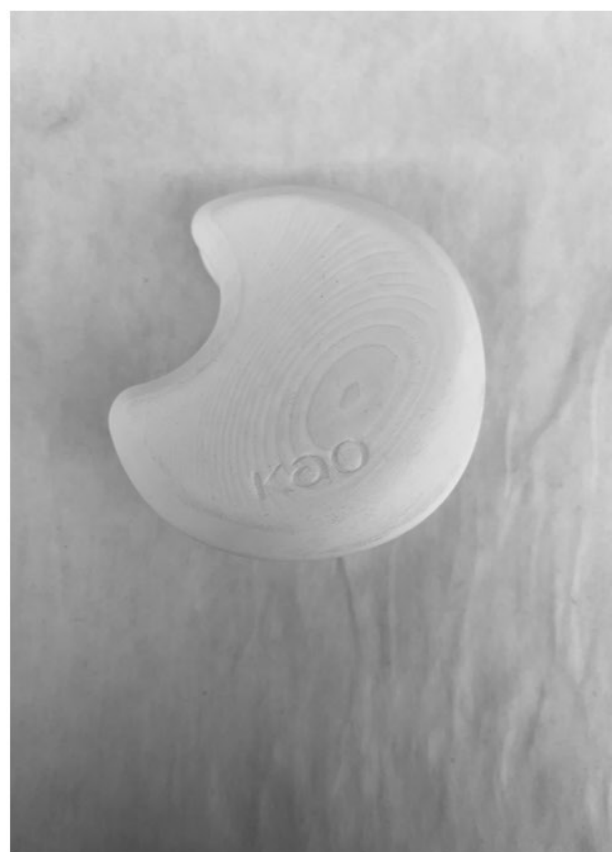

Straw Rope
Better gripping, hanging

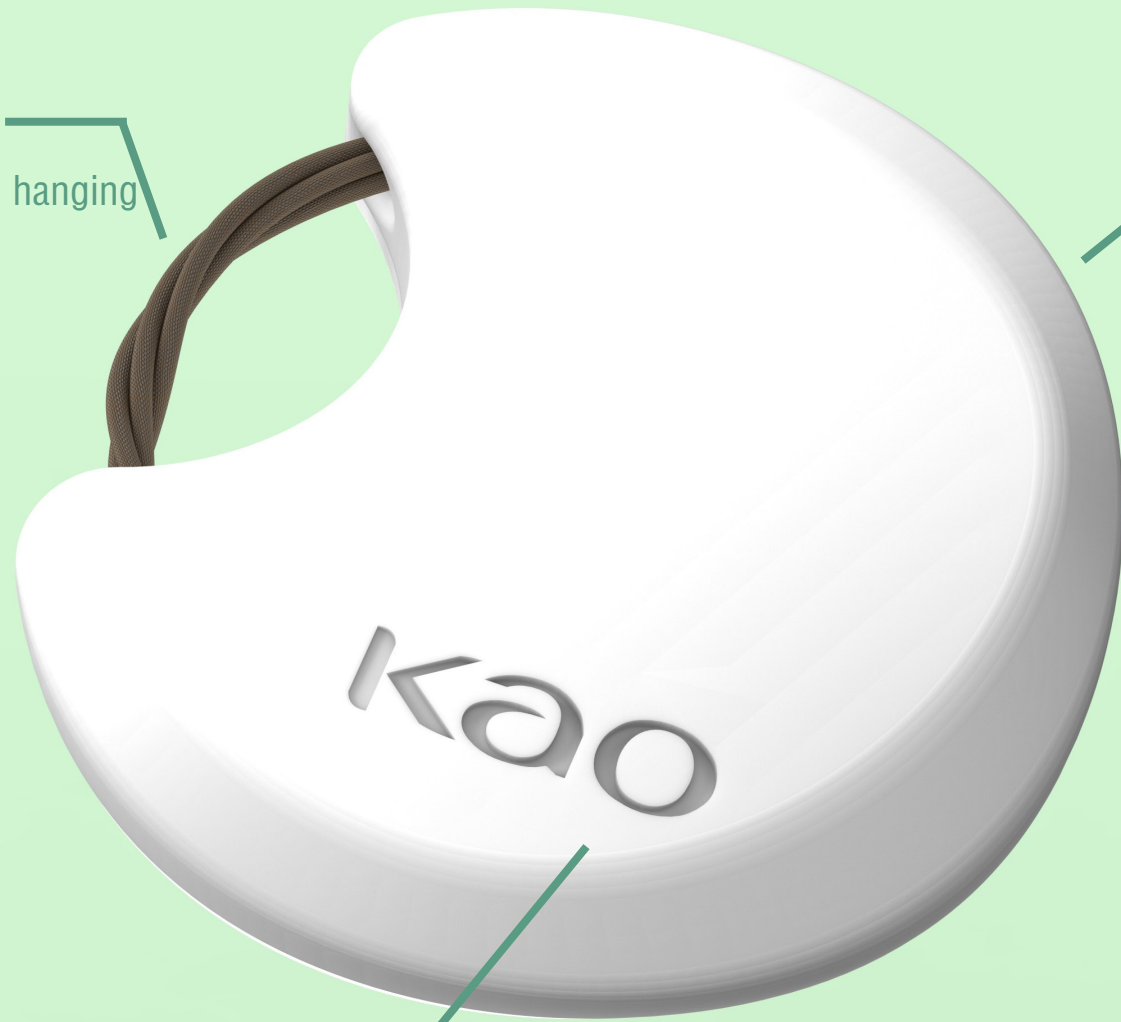

Company Logo

Moon Shape
Associated with the logo



FINAL
MODEL

Moon Shape Groove
Easy for dry water

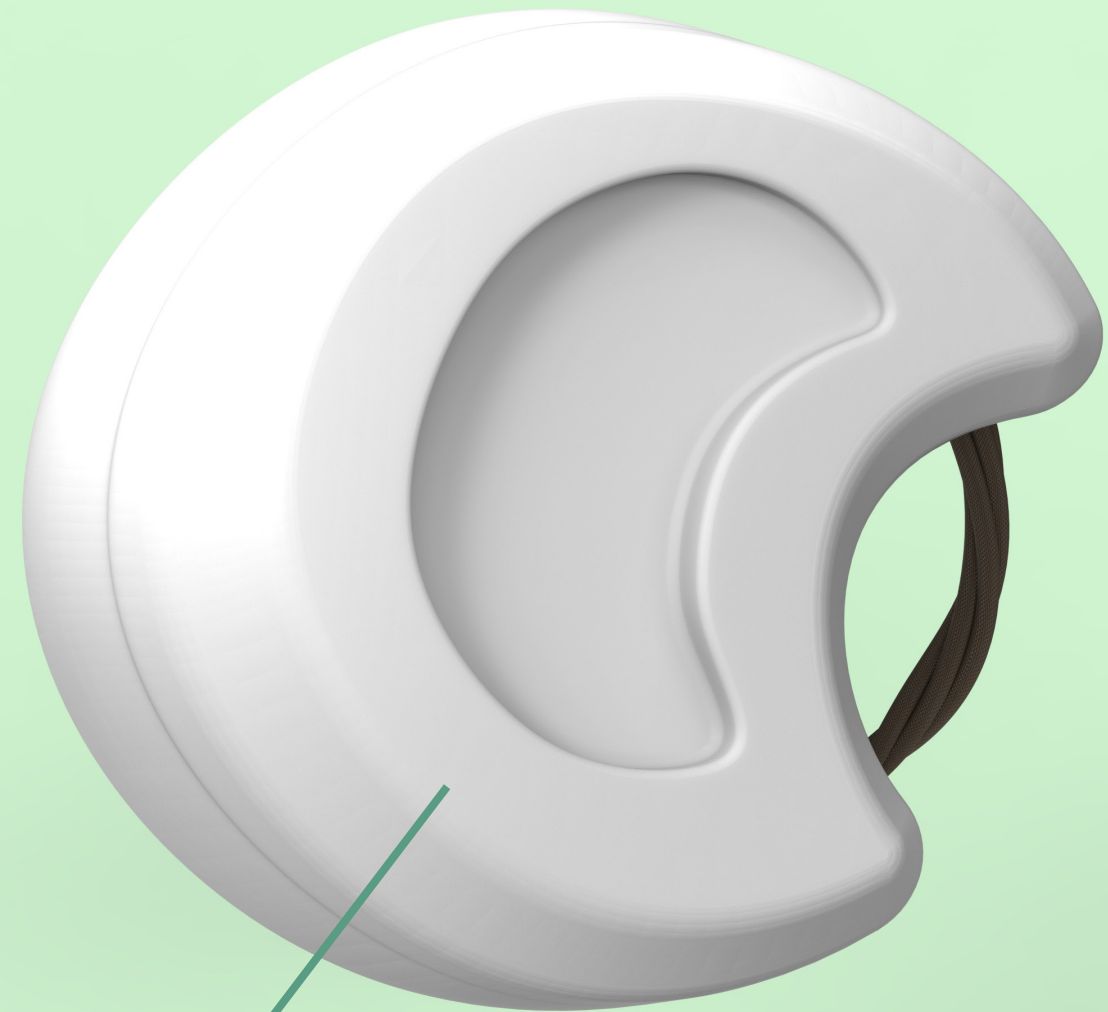





SOLOIST

Saxophone Microphones

For

” Street performance

Interview



Justin Played in the school orchestra
Five years of saxophone experience

"Sometimes the microphone touches the saxophone by mistake."

"The adjustments before the saxophone is played are somewhat complicated."



Stella Played in the school orchestra
Three years of saxophone experience

"The sax carrying case weighs a lot"

"There is no room for a microphone."



Brian Had experience playing on the streets
Played saxophone in a band

"Street performances don't have specialized equipment for special microphones."

"Microphone does not show power level"

PAIN

POINTS



No storage space



Easy to hit the microphone



Unable to display battery level

SKETCHES

INSPIRATION:

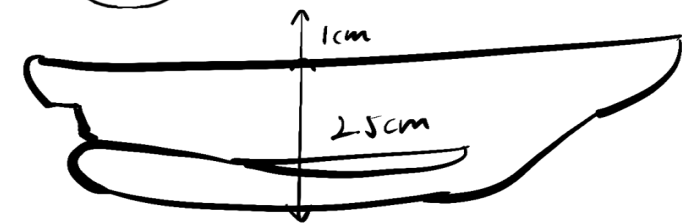
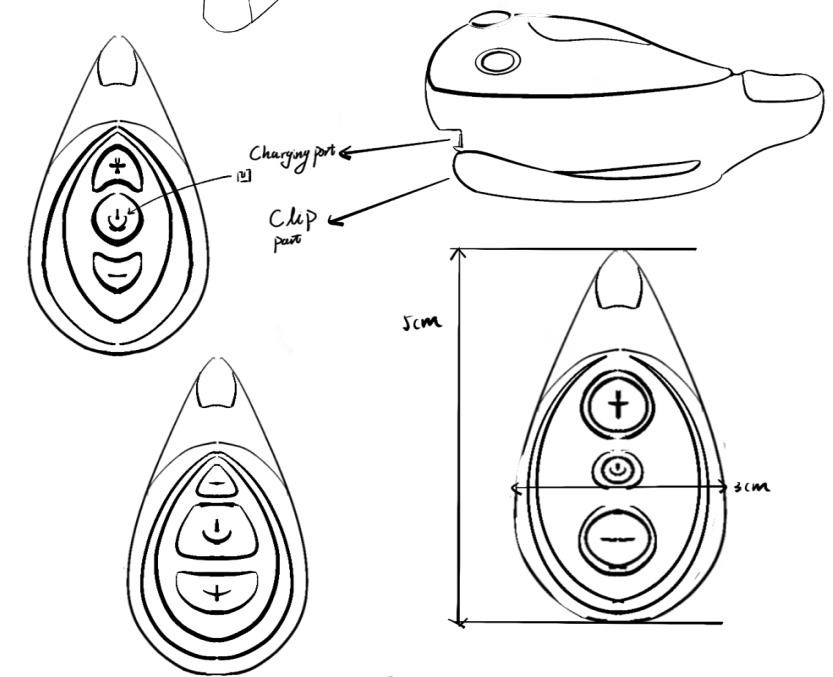
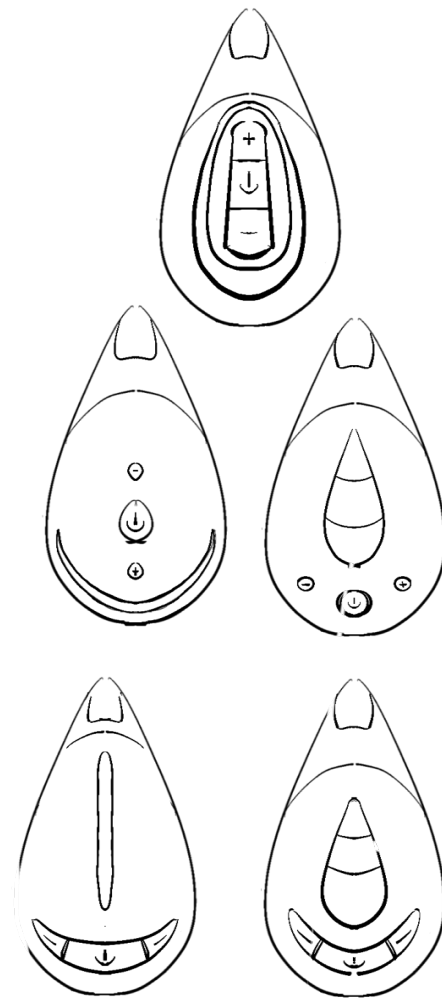
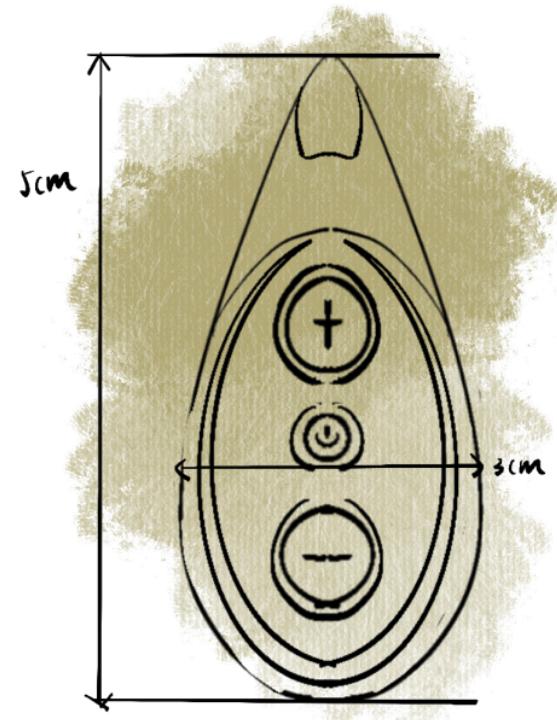
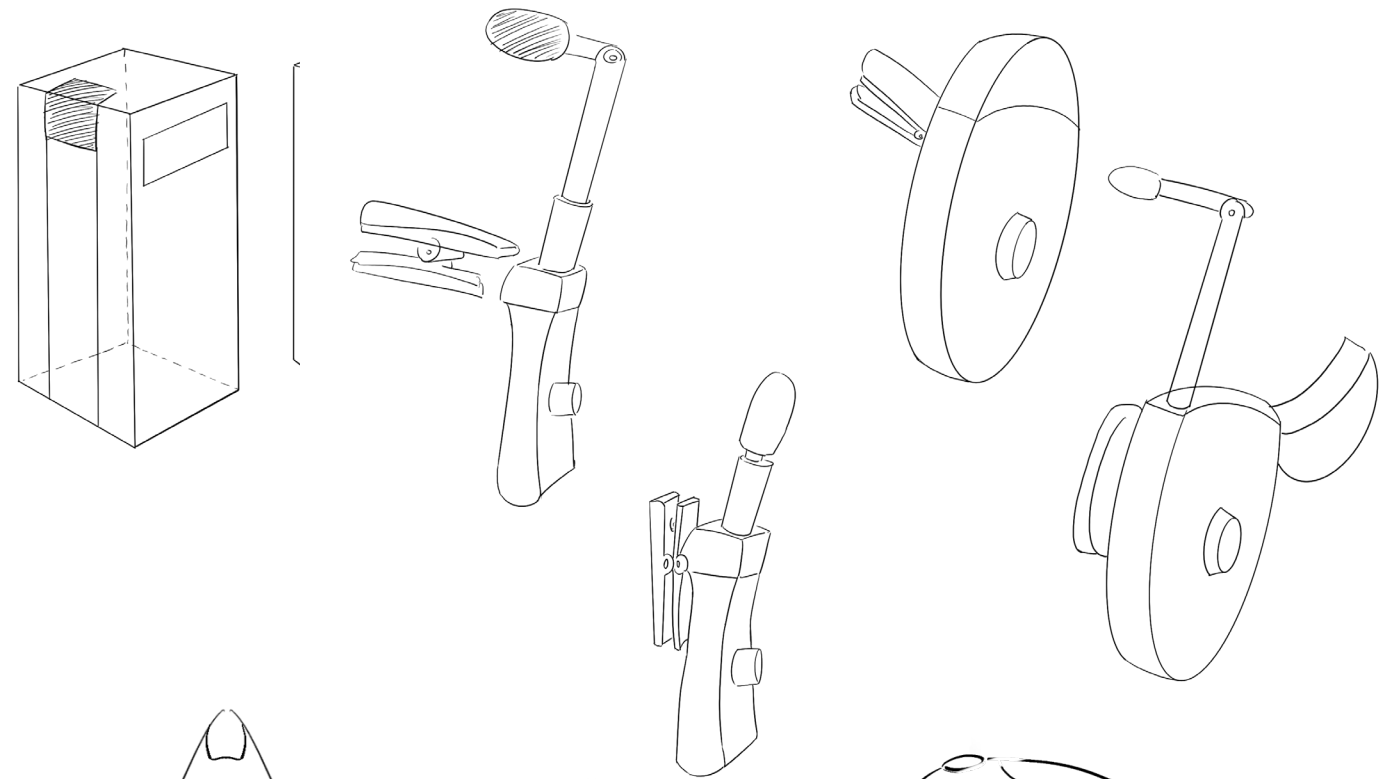
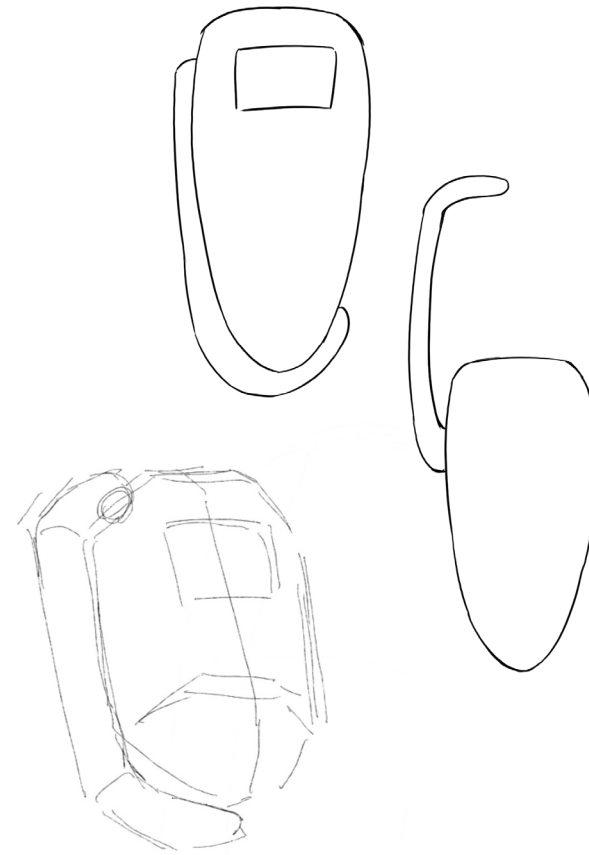

FINAL
MODEL

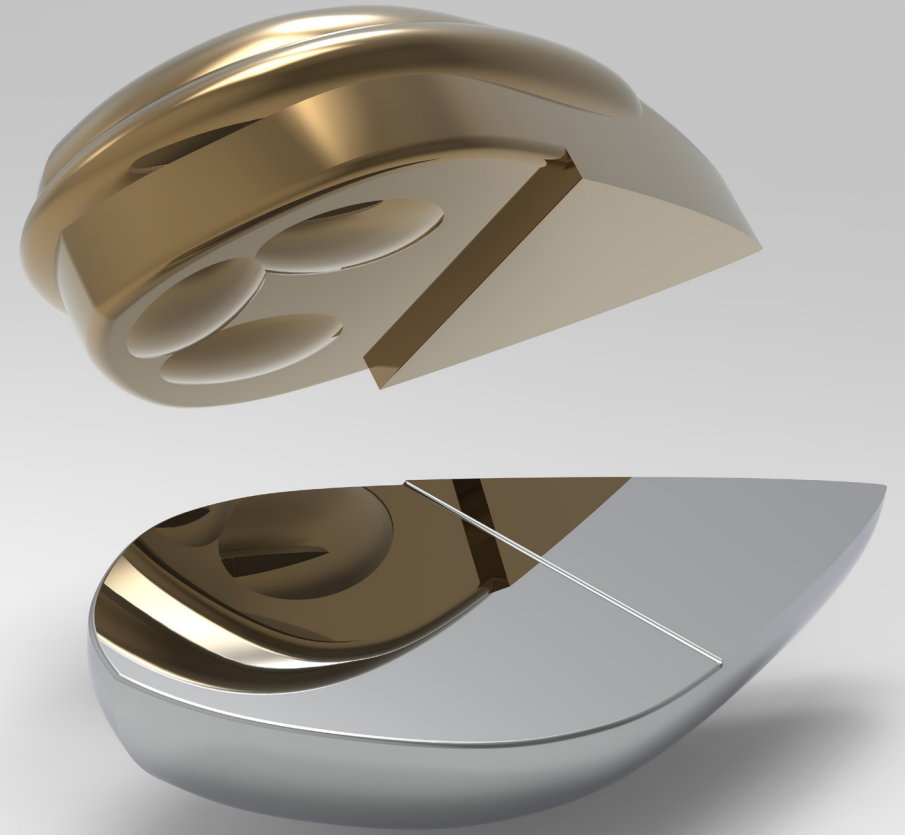
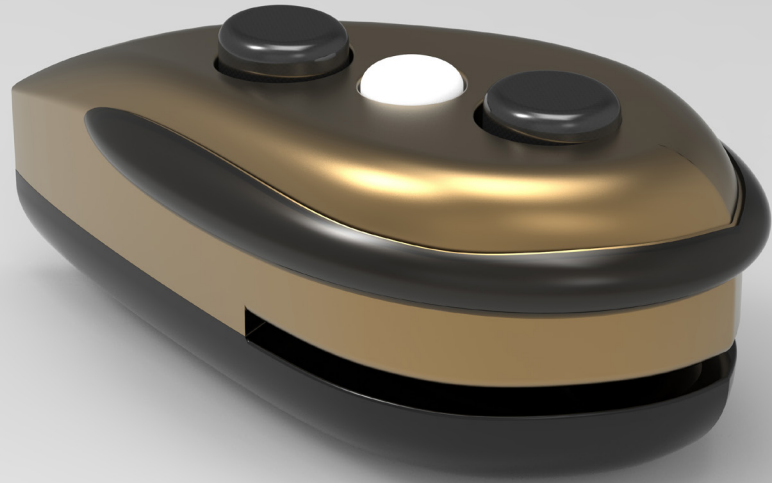

Power Button

Volume Buttons

Battery Level Display

Dots

Rubber Base

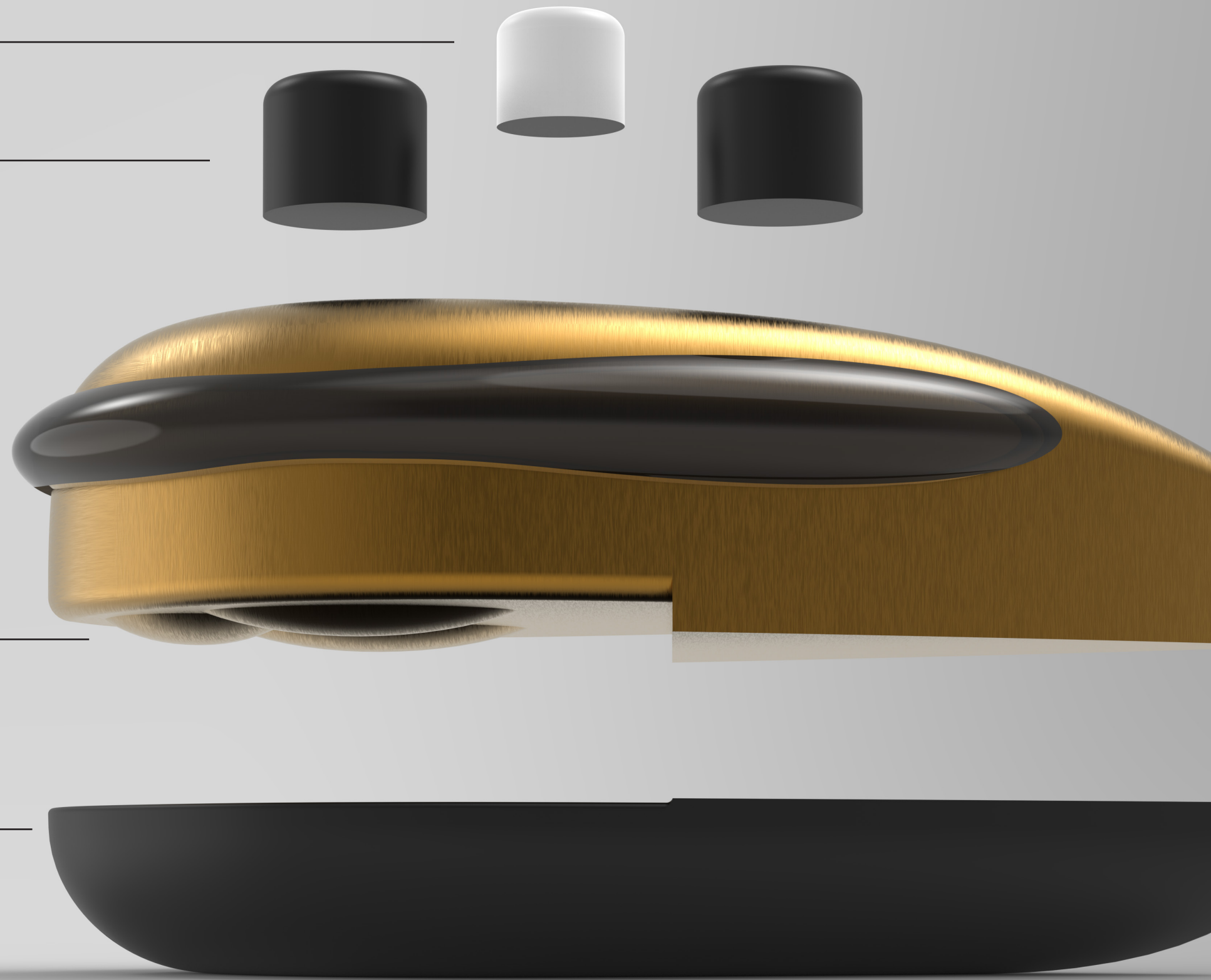

IN-USE STAGE



How

Soloist Works

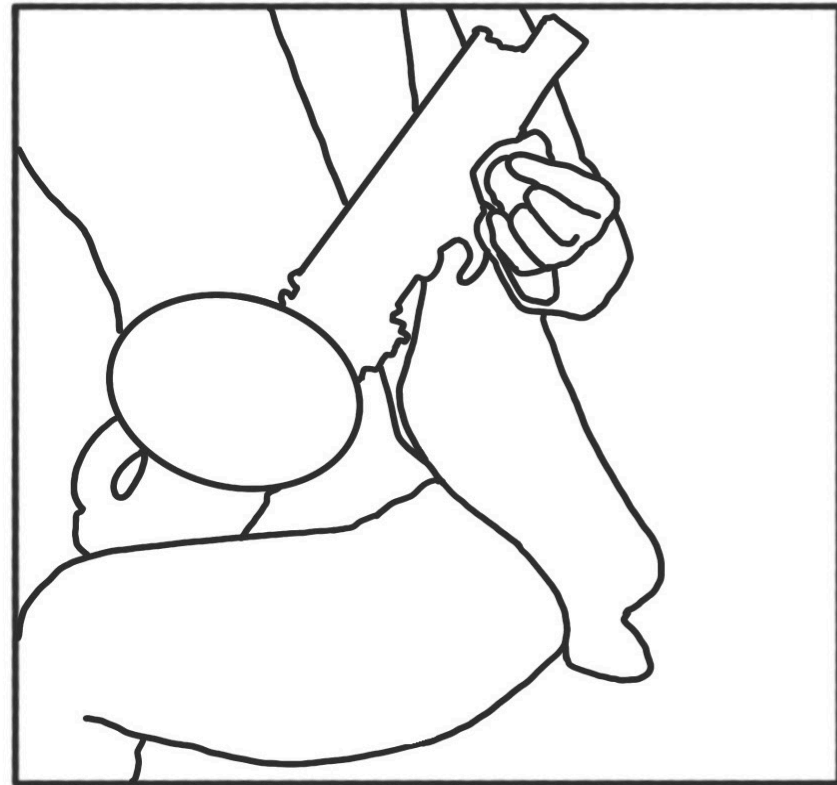

Start assembling the saxophone

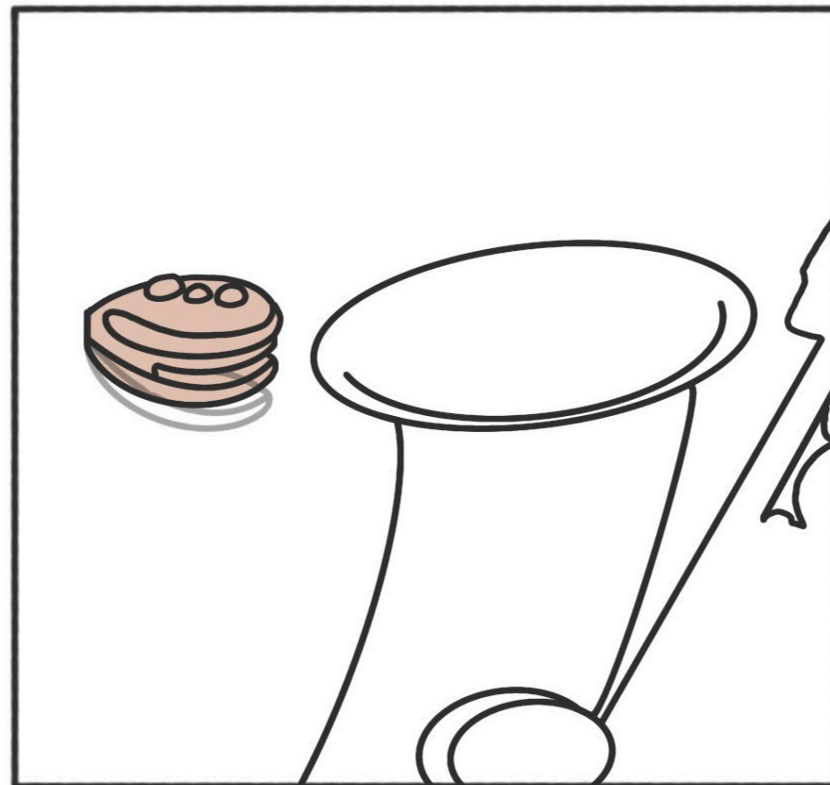

Use the soft plastic part of the clip to hold the edge

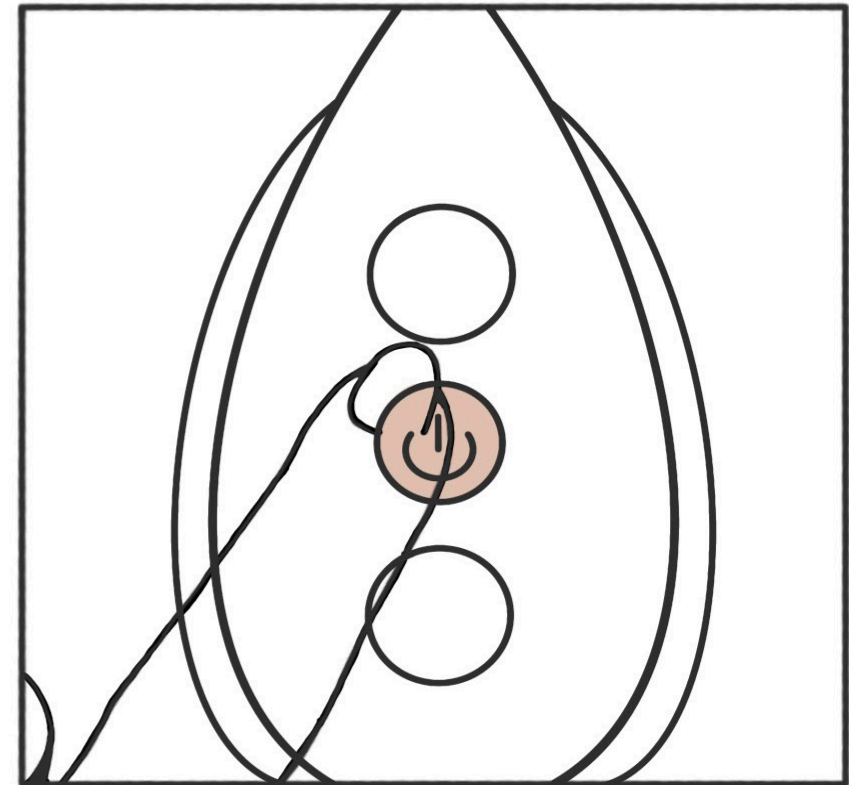

Click the start button

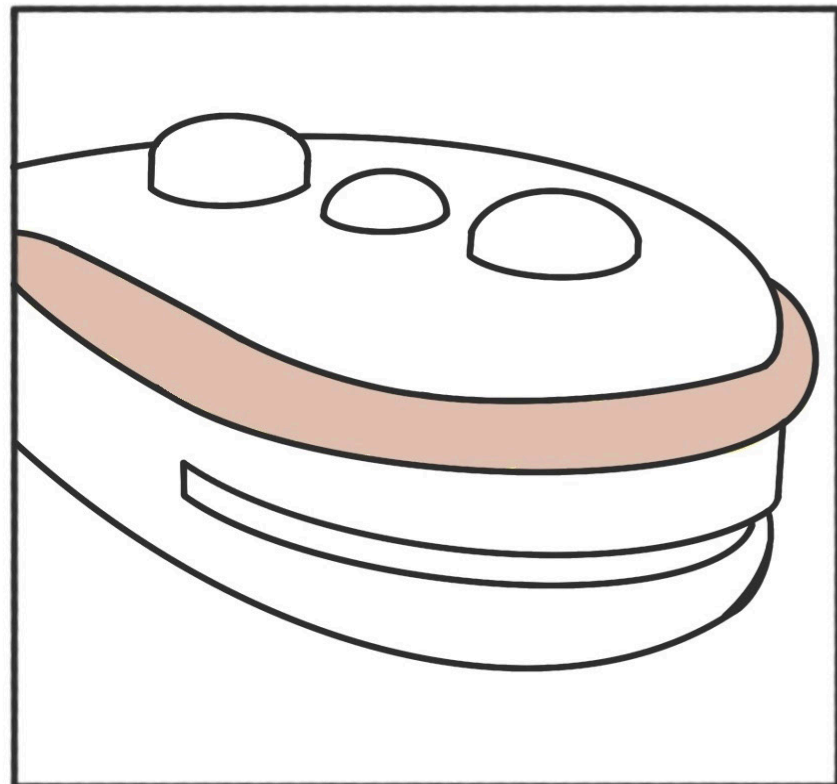

Check the power display section

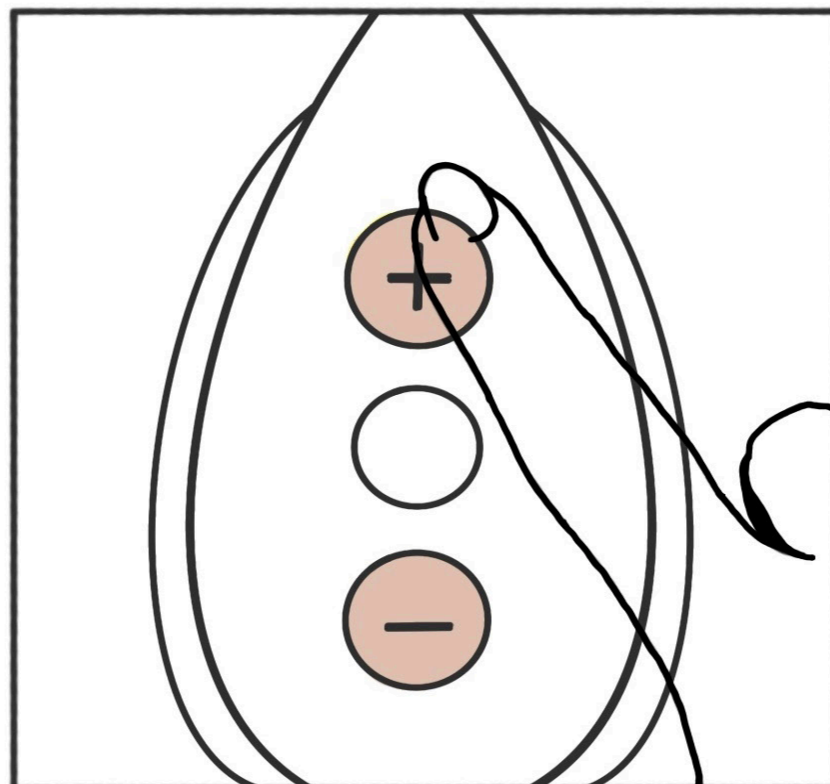

Tap the volume keys to adjust the volume

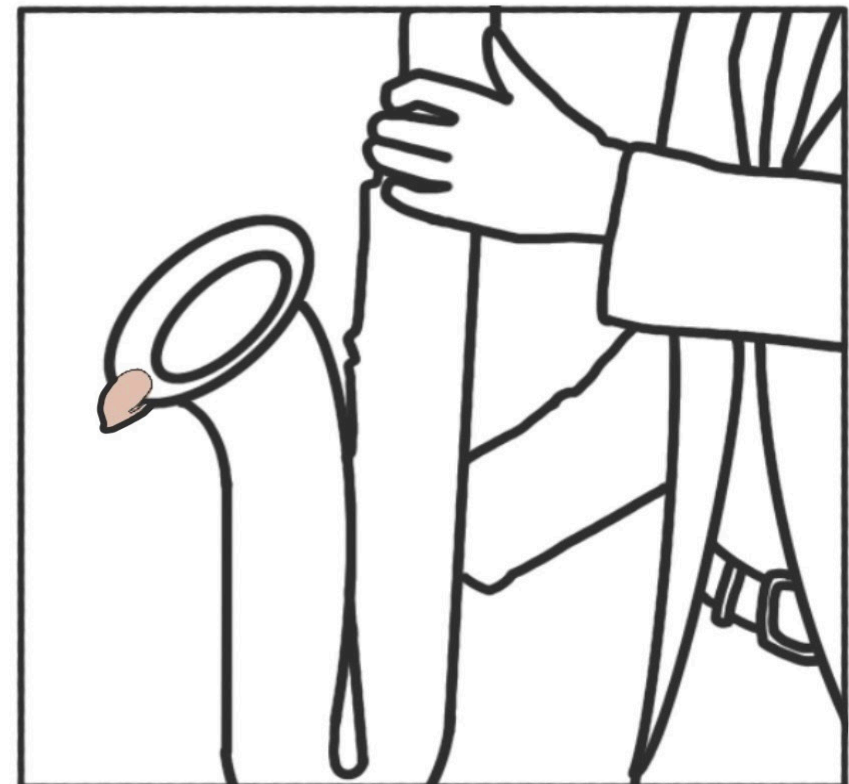

Start playing



Personal Projects

Sketching and model skills

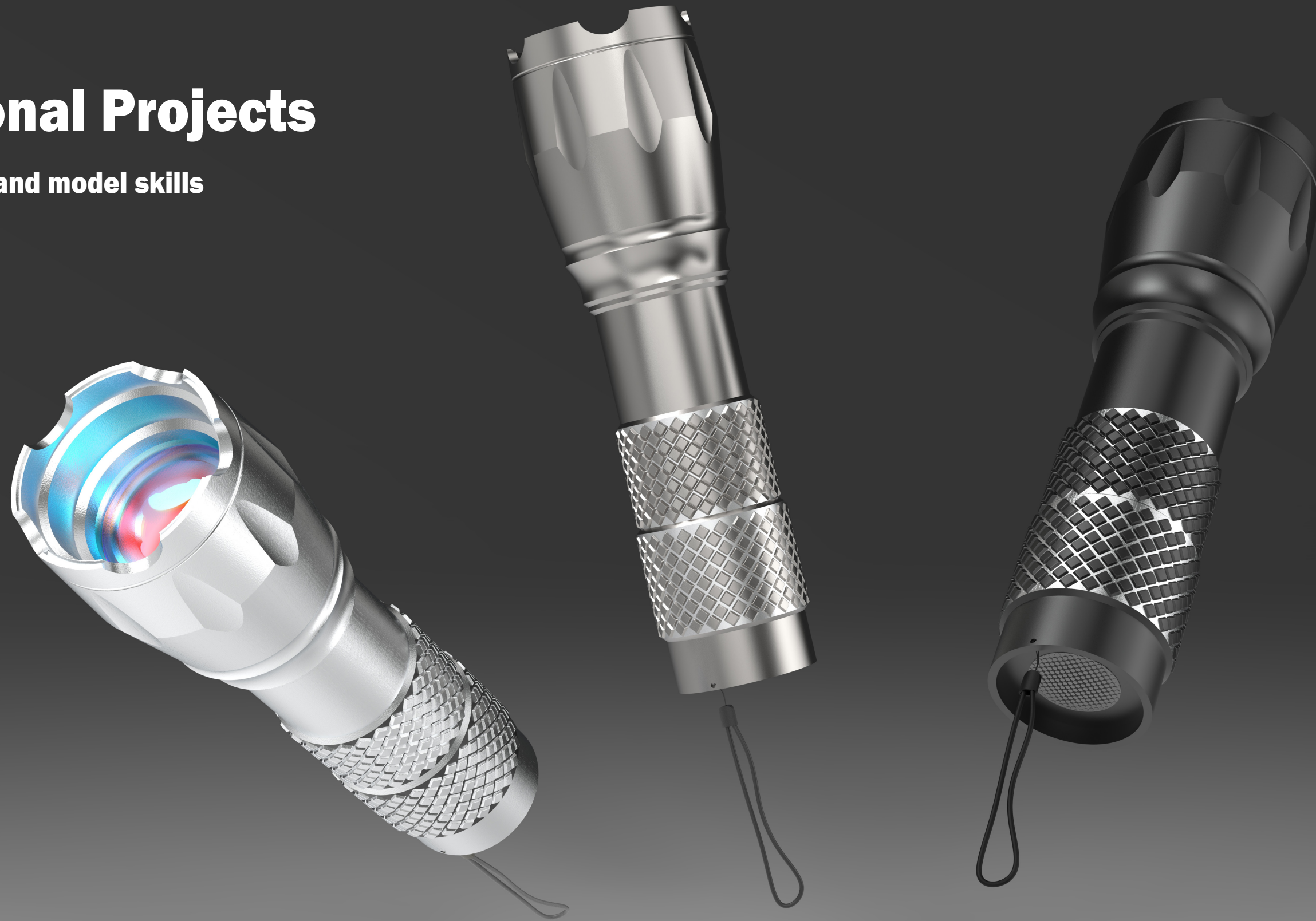

Model:
Robot

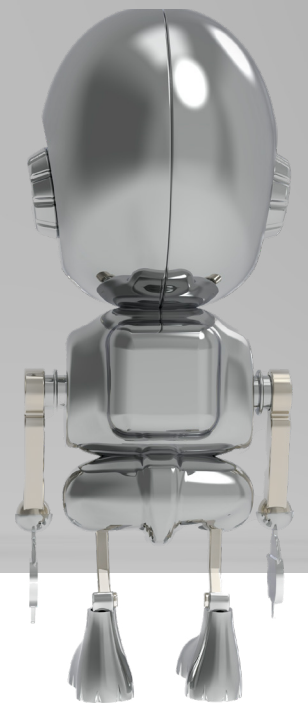
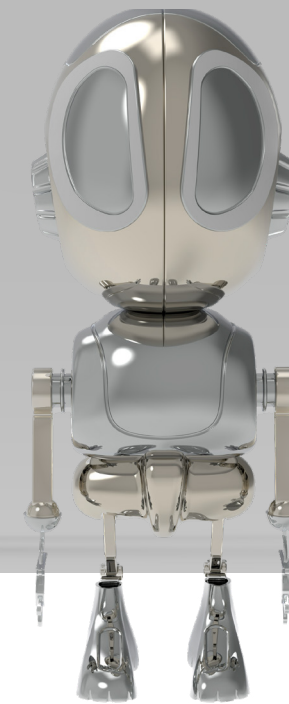
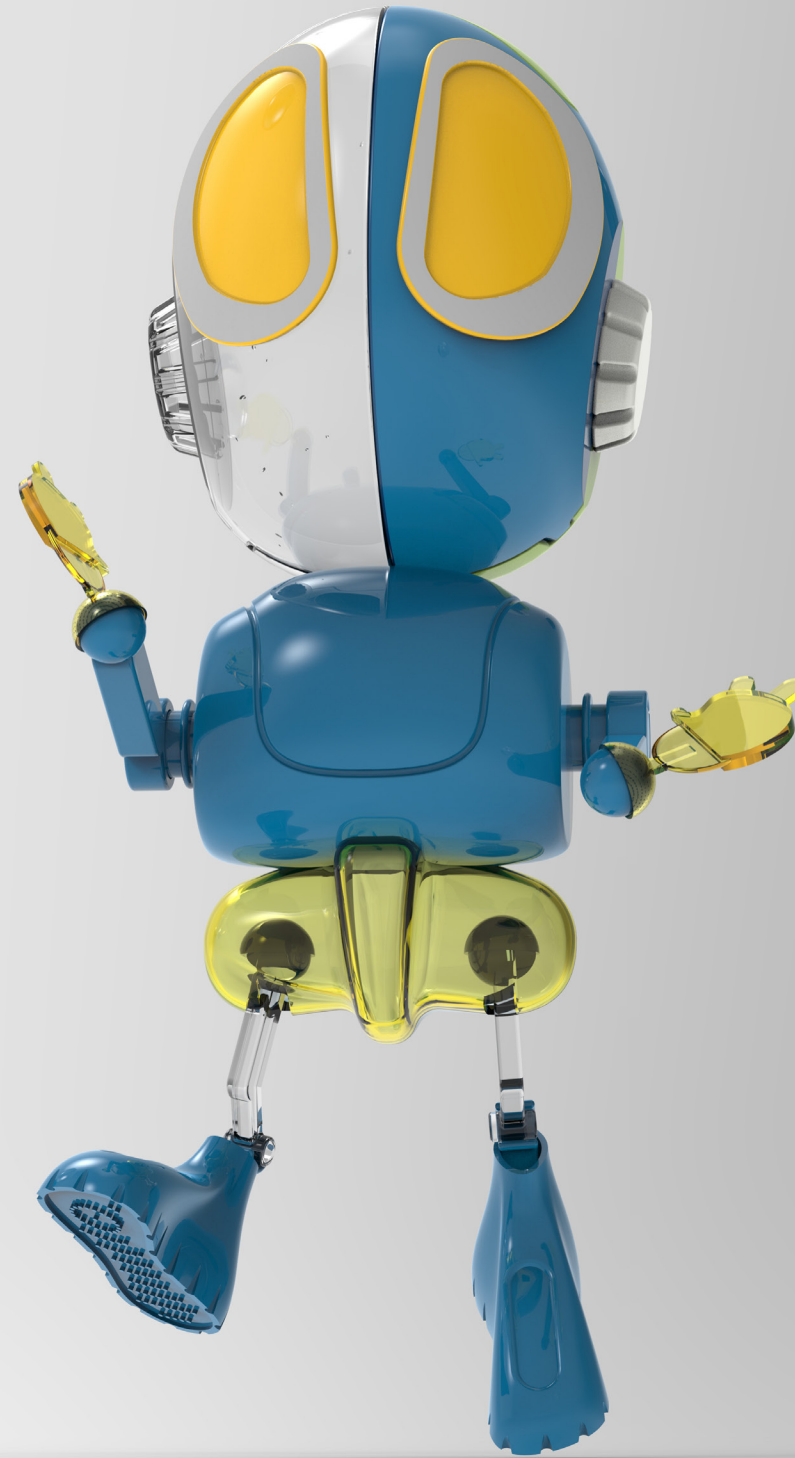
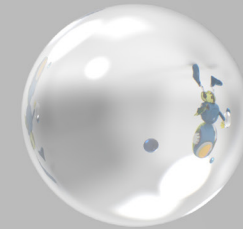
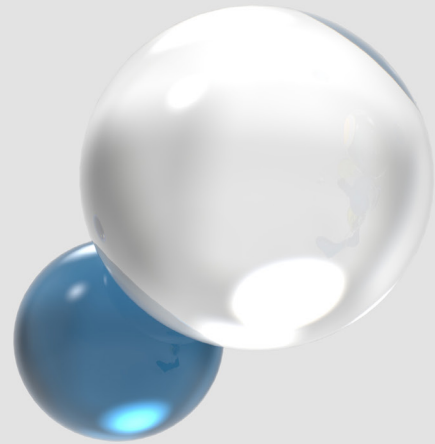
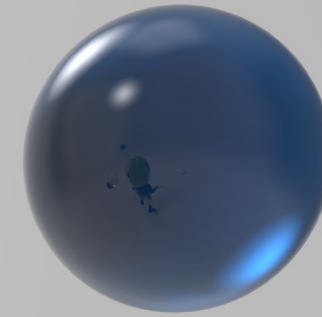
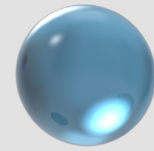



Model:

Flashlight



Sketching:

Suitcase

Coffee Pot

Lunchbox

YouHua Zhang

zhangyouhua@cca.edu

Number: 628.724.1603